

N**Monteringsanvisning****EN****Assembly Instructions****S****Monteringsanvisning**

Produkt nr. / Product no. / Produkt nr.

60-164-910**Gul**

Ord. nr. _____

Dato. _____

Sign. _____

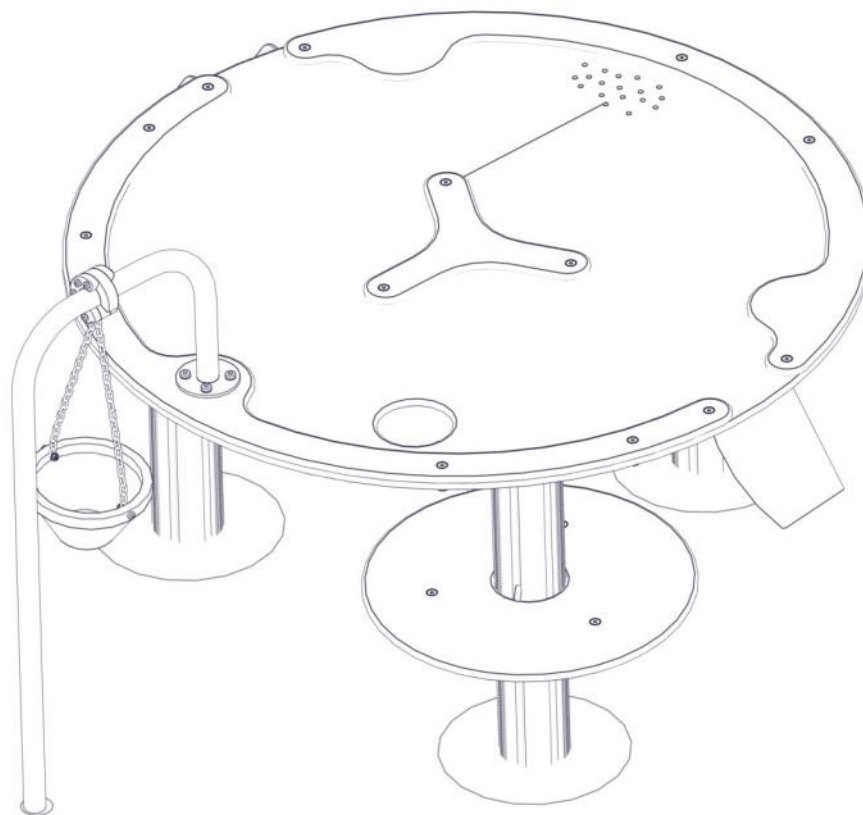

Søve AS
Grønnvoldveien 290
3830 Ulefoss - Norway
Tlf: +47 35 94 65 65
www.sove.no



Søve AB
EA Rosengrensgatan 32
421 31 Västra Frölunda
Phone: +46 (0)31 773 97 00
www.sove.se

Monteringstips / Assembly Advice / Monteringsstips**N**

- Les monteringsanvisningen nøye før montering.
- Monter elementene i rekkefølgen som vist.
- Boltene bør ikke skrues for hardt til før alt er montert, vatret og loddet. Skru så boltene til.
- NB! Ved bruk av drill, kan boltene ryke.
- På grunn av at solen kan gjøre rutsjeflaten veldig varm, bør rutsjebanens utløp vende mot nord-øst eller nord-vest.
- Er lekeutstyret plassert i naturlige ferdselstraséer må området sikres mot gjennomgang.
- Innspringningshinder bør vurderes rundt lekeapparater hvor det er stor bevegelse, f.eks. ved huskestativ.
- Det bør være fritt innsyn til lekeutstyr som er beregnet for barn under 3 år.

NB! Under monteringsarbeidet må utstyr, som ikke er forankret forsvarlig i bakken, sikres slik at det ikke velte.

Området må avstenges under montering av apparatene med sperrebånd eller lignende.

EN

- Read the instruction carefully before assembling the play unit.
- Assemble the components in the sequence shown in these instructions. Fixings must not be fully tightened during assembly. Before casting the foundations, the structure must be level and plumb, at which point all fixings are tightened. PS! If use of drill, the bolts may be wrecked.
- Avoid positioning the slide facing due south because of overheating – ideal positions are facing north-east or north-west. Secure the construction-area to prevent people from walking through it.
- Consider installing barriers around play-equipment which gives rise to a lot of activity – i.e. swings.
- Ensure that clear vision is possible across the play area so that supervision is possible from any position, particularly where children under 3 years of age will be playing.

NB! During assembly of the equipment, ensure that all structures are securely propped, especially when left overnight. Also ensure that equipment is supported

Monteringstips / Assembly Advice / Monteringsstips**S**

- Läs monteringsanvisningen noga före montering.

- Montera delarna i den ordningen som anvisas
- Skruvarna bör inte skruvas för hårt tills allt är monterat, i våg och lodat.









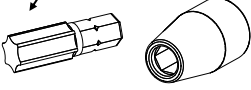

OBS! Används elektrisk skruvdragare, kan bulten gå sönder. Hårdra därför manuellt!

- Solen kan göra att rutchbanan blir väldigt varm. Banans nedfart rekommenderas att vändas i norrlig riktning
- Om lekplatsen placeras vid en gångväg mm bör området säkras mot genomfart av gående och cyklister.
- Insprängningshinder bör placeras runt lekutrustning med stor rörelse, t ex, gungställning.
- Det bör vara fri insyn till lekutrustning beräknat till barn under 3 år.

OBS! Under monteringsarbete bör utrustningen som inte ska förankras i marken, ställs så att den inte kan välta.

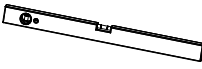
Området måste spärras när lekutrustningen byggs upp, med avspärrningsband eller liknande.

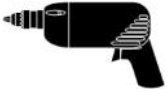
Nødvendig verktøy / Tools required / Nödvändiga verktyg





<p>(N)</p> <p>(EN)</p> <p>(S)</p>	<p>(A)</p> 	<p>(B)</p>  <p>Torx Nr 45 High quality</p> 	<p>(C)</p>  <p>13 + 17mm</p> 	<p>(D)</p> 	<p>(E)</p> 
		<p>Metermål Metric measure Tumstock</p> 	<p>16 V</p> 	<p>Merkebånd Mark ribbon Märkeband</p> 	<p>5 mm 6 mm</p> 



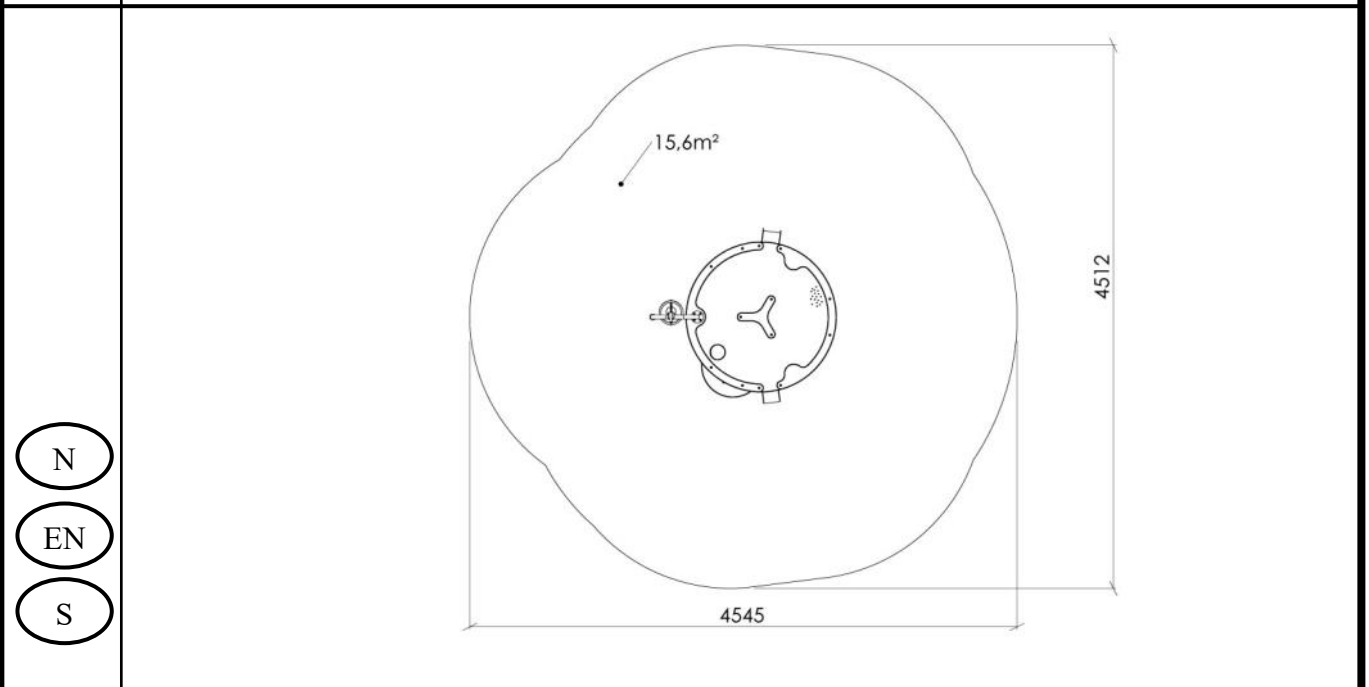

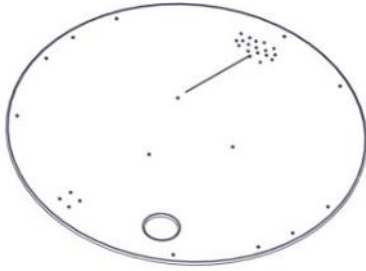
Nødvendig antall personer / Number of persons required / Rekommenderad antal personer

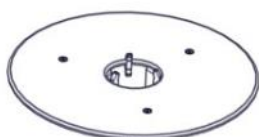

Anbefalt arealbehov ved montering / Recommended working space / Rekommenderad arealbehov vid montering



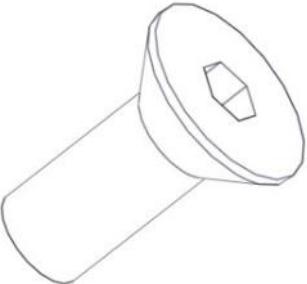

Boltepakker for / Boltpackage for / Bultpaket för		Sign. _____.		
Gul 60-164-910	Navn	Artnr/ dimensjon	Ant	Lev
	Stolpe Ø 110 L=1200 (600-600) Grå Med beslag montert.	06-200-509	3	
	Mudtable bottom Ø 1250x 12 Grå	06-200-500	1	
	MudTable Ring Ø1250 del1 Gul	06-200-501	1	
	MudTable Ring Ø1250 del2 Gul	06-200-502	1	
	MudTable kryss Gul	06-200-503K (se egen del- montering)	1	
	MudTable bucket rest Ø 520 Grønn	06-200-504K (se egen del- montering)	1	

Boltepakker for / Boltpackage for / Bultpaket för		Sign. _____		
Gul 60-164-910	Navn	Artnr/ dimensjon	Ant	Lev
	MudTable utløp type 1 Rød	06-200-506K (se egen del- montering)	1	
	MudTable utløp type 2 Rød	06-200-507K (se egen del- montering)	1	
	MudTable rør H600 Grå	06-200-515K (se egen del- montering)	1	
	Bøtte med delbare krok	06-200-518K (se egen del- montering)	1	
	Produktmerking	06-500-500 (se egen del- montering)	1	
	Unbrako M8x40 forsenket hode	04-034-040	6	

Boltepakker for / Boltpackage for / Bultpaket för

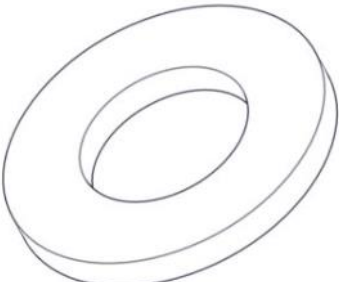
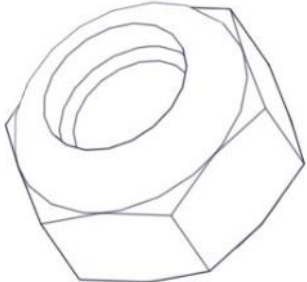
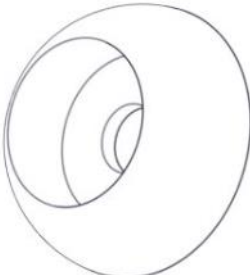
Sign. _____.

Gul 60-164-910	Navn	Artnr/ dimensjon	Ant	Lev
	Skive M8	04-050-008	6	
	Låsemutter M8	04-040-008	6	
	Sikkerhetslette Kropp 32 Sort	05-301-045	6	
	Sikkerhetslette 20mm hode Sort	05-301-044	6	

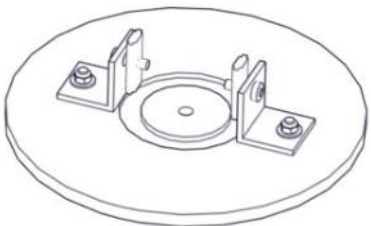
Boltepakker for / Boltpackage for / Bultpaket för		Sign. _____.		
Gul 60-164-910	Navn	Artnr/ dimensjon	Ant	Lev
	Fundament Støp			
	Støpefundament Ø110 stolpe	00-003-111K (se egen del- montering)	3	
	Fundament Nedgravning			
	Nedgravningsfundament Ø110 stolpe	07-400-101K (se egen del- montering)	3	

Boltepakker for / Boltpackage for / Bultpaket för

Sign. _____.

Gul 60-164-910	Navn	Artnr/ dimensjon	Ant	Lev
Overflatemon- tering				
	Fundament 1xØ110 for betong- dekke	00-003-113K (se egen del- montering)	3	
	Stolpe Ø 110 må kappes Rør må kappes	06-200-509 06-200-515K	(3) (1)	

Ref
NS-EN 1176-1
§4.2.8.5

(N) (EN) (S)
Bakkenivå Ground level marknivå

Tykkelse/Thickness

betong
concrete
betong

Stolpe kappes: Lengde stolpe - 600 + tykkelse

Fundamentering med betong / Foundation concrete / Förankring med betong

- (N) Støtdempende materialer
- (EN) Impact attenuating materials
- (S) Støtdämpande material Ref NS-EN 1176-1 §4.2.8.5

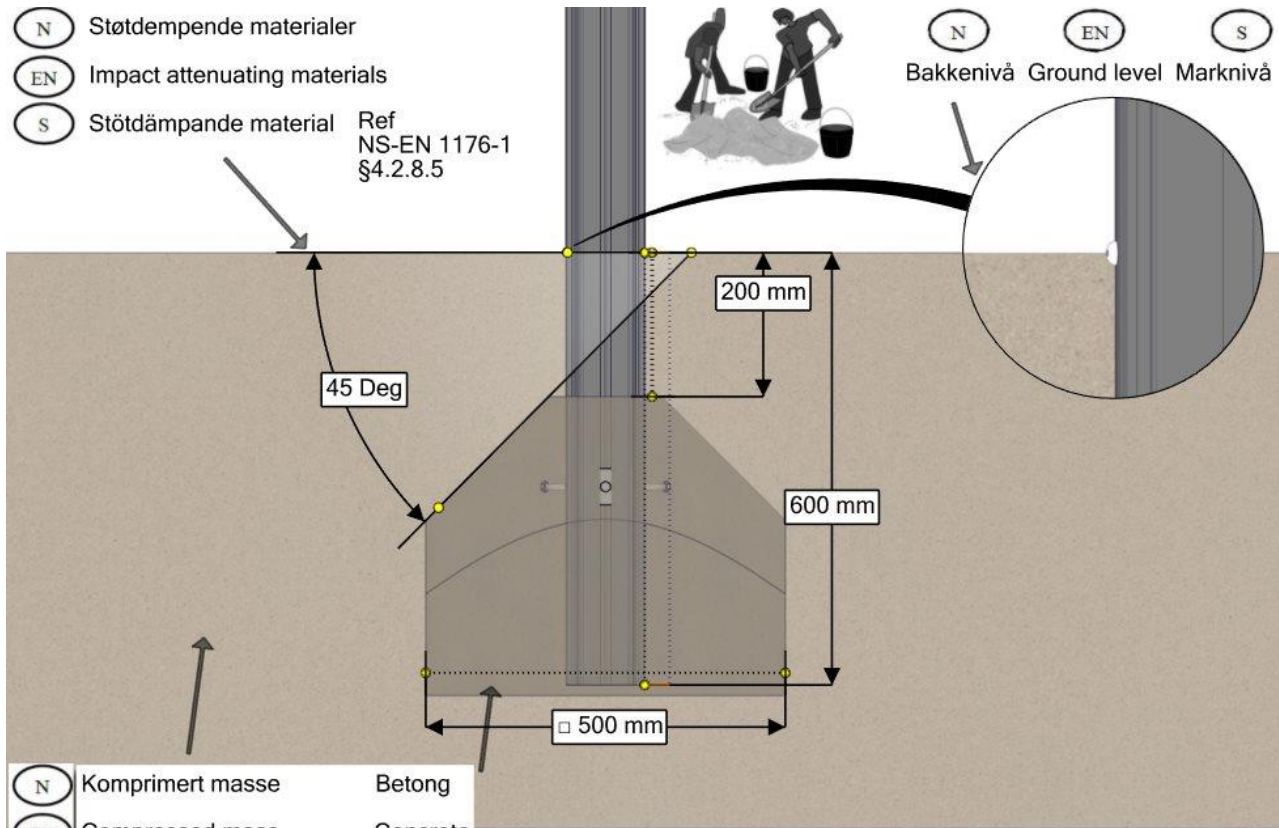

- (N) Komprimert masse Betong
- (EN) Compressed mass Concrete
- (S) Komprimerad massa Betong

Fundamentering uten betong / Foundation without concrete / Förankring utan betong

- (N) Støtdempende materialer
- (EN) Impact attenuating materials Ref NS-EN 1176-1 §4.2.8.5
- (S) Støtdämpande material

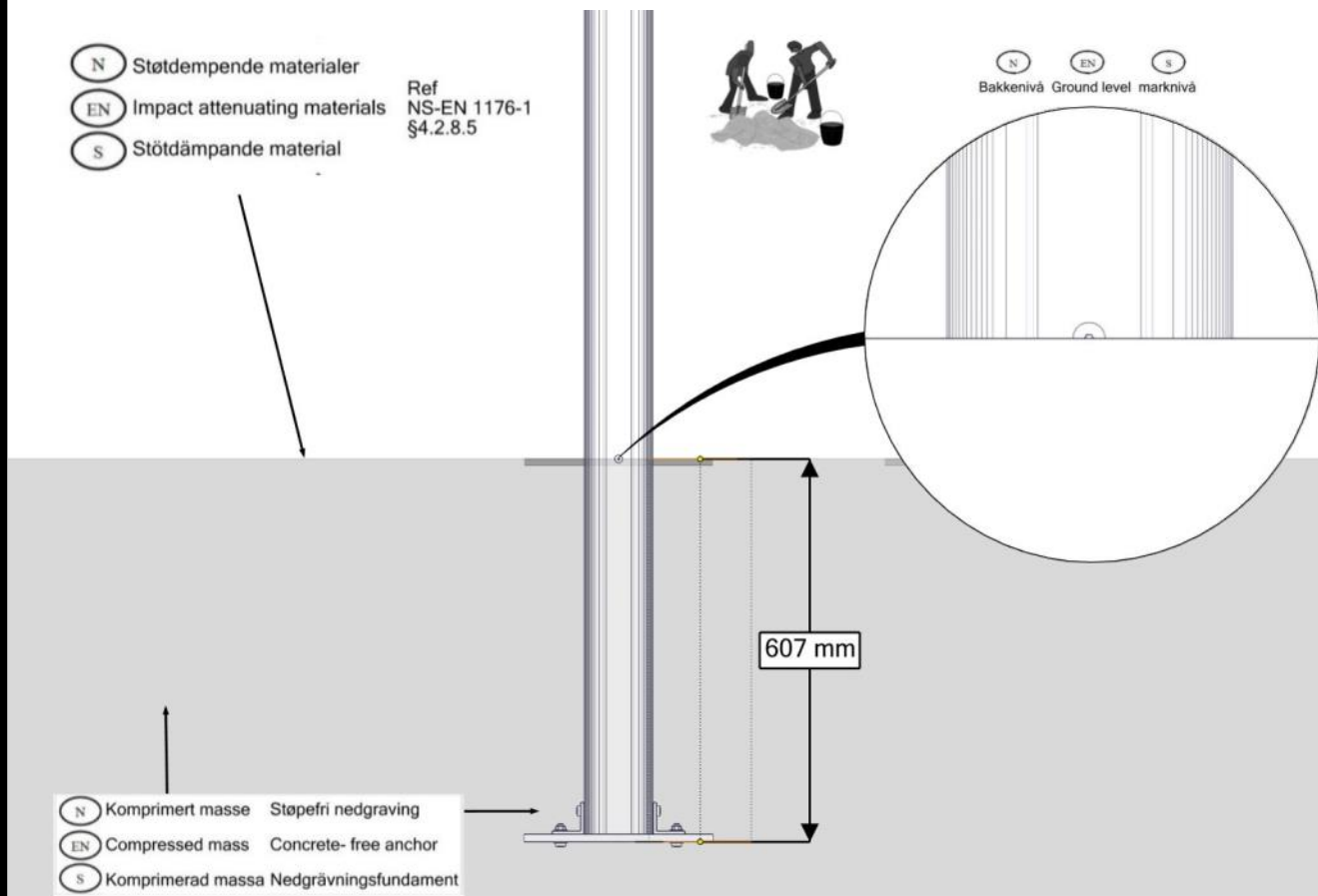

- (N) Komprimert masse Støpefri nedgraving
- (EN) Compressed mass Concrete-free anchor
- (S) Komprimerad massa Nedgravningsfundament

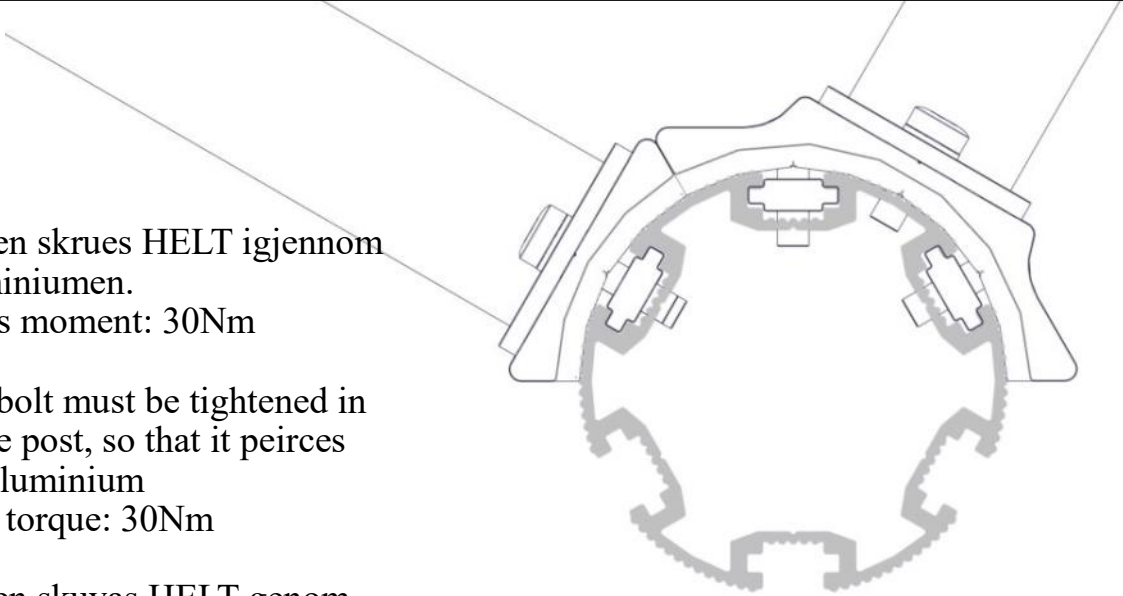
N	<p>Bolten skrues HELT igjennom aluminiumen. Maks moment: 30Nm</p>			
EN	<p>The bolt must be tightened in to the post, so that it peirces the aluminium Max torque: 30Nm</p>			
S	<p>Bulten skuvas HELT genom aluminiumen. Maks vridmoment: 30Nm</p>			
				
NO	Betongkvalitet	C25/30		
SE	Betongkvalitet			
EN	Concrete quality			
NO	Mengde betong	0,3	m ³	
SE	Mängd betong			
EN	Amount of concrete			
NO	Fundament størrelse	0,5 x 0,5 x 0,4	m	
SE	Stiftelsestorlek			
EN	Foundation size			
NO	For sikkerhet må fundamentene med sand eller myk jord være minst 50% større i areal			
SE	För säkerheten måste grunden med sand eller mjuk jord vara minst 50% större i området			
EN	For safety, the foundations with sand or soft soil must be at least 50% larger in area			
NO	Tyngste element	06-200-500	21	Kg
SE	Tyngsta element			
EN	Heaviest element			
NO	Største element	06-500-500 06-200-515	Ø 1,25x0,02 1,4x0,4x0,05	m
SE	Största element			
EN	Biggest element			

Fallhøyder / Free height of fall / Fallhöjder

Fallhøyde = 0,63 meter

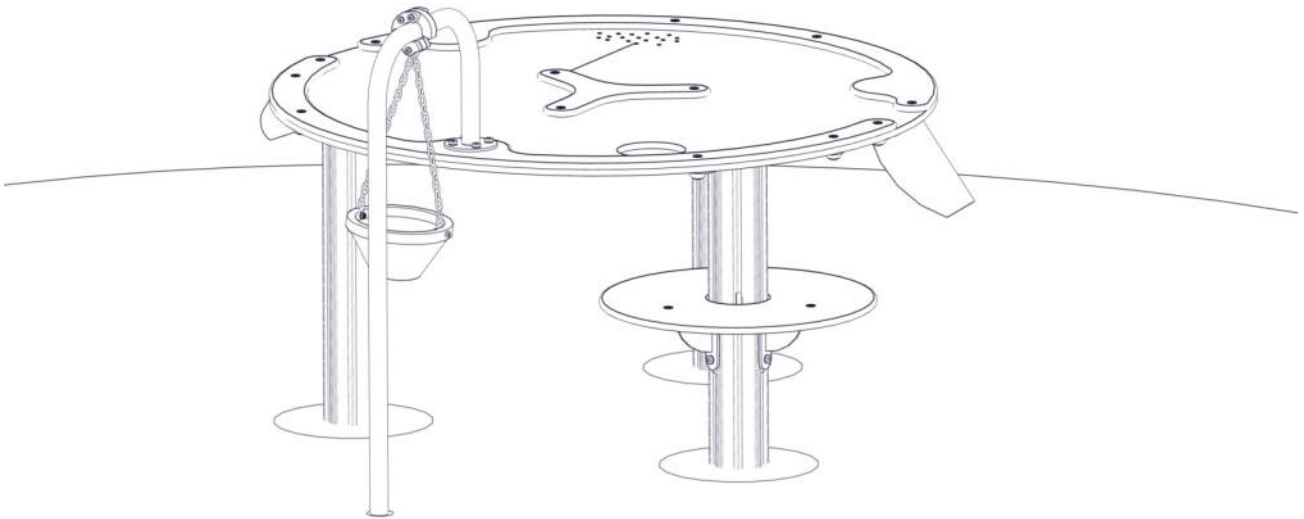
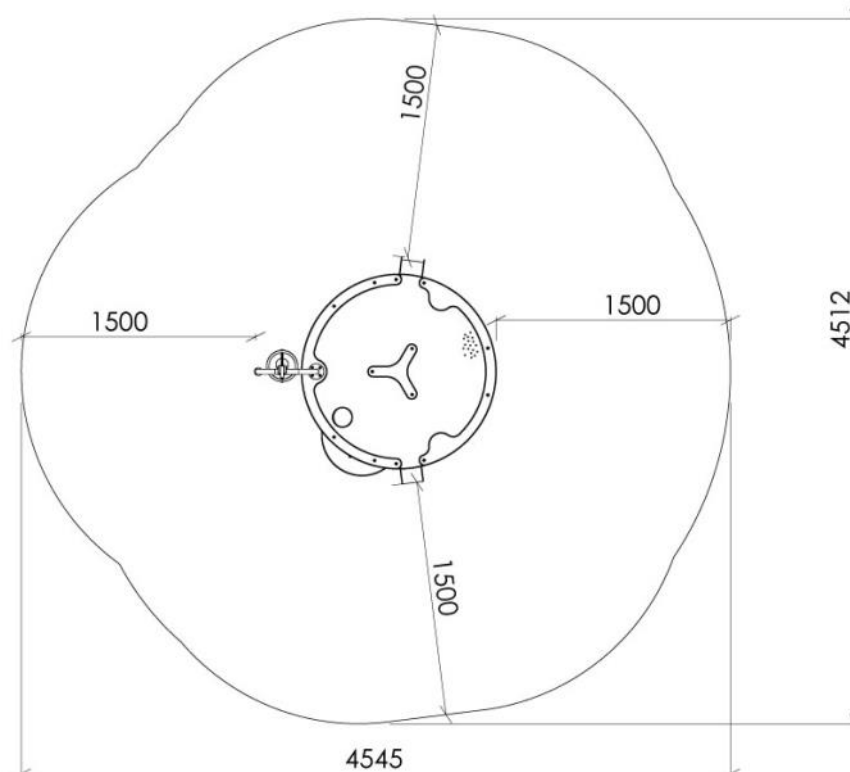
**Sikkerhetszone / Safety zone / Säkerhetszon**

Montering av lekeapparatet / Assembly instructions / Montering av lekredskapet

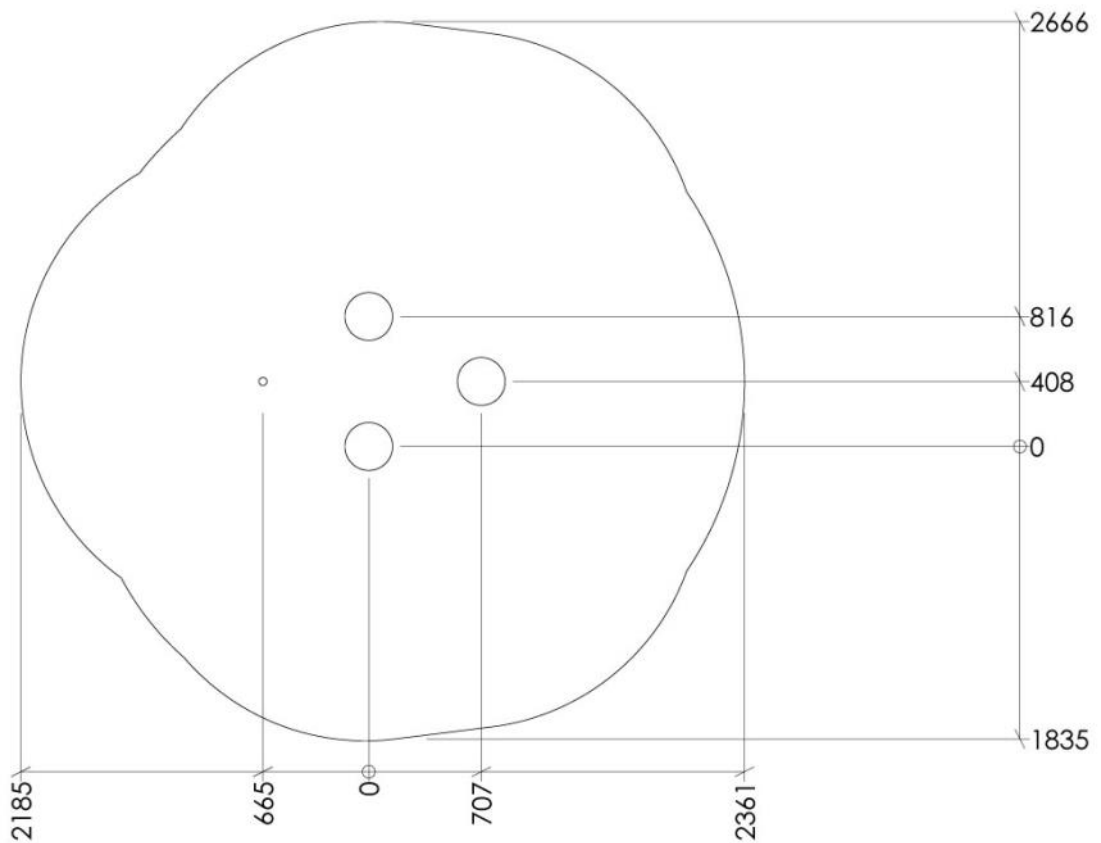

Se separat delmontering for detaljer
 See separate assembly for details
 Se separata delmontering för detaljer

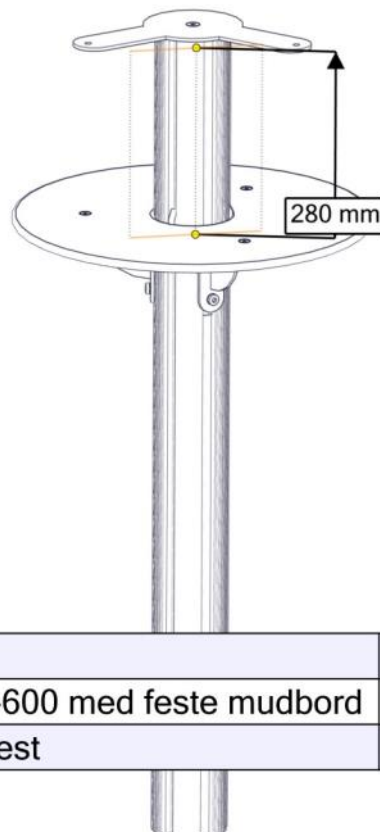

Part Name	Article nr.	Qty
Stolpe L1100=500-600 med feste mudbord	06-200-509	1
MudTable bucket rest	06-200-504K	1

Se separat delmontering for detaljer
 See separate assembly for details
 Se separata delmontering för detaljer

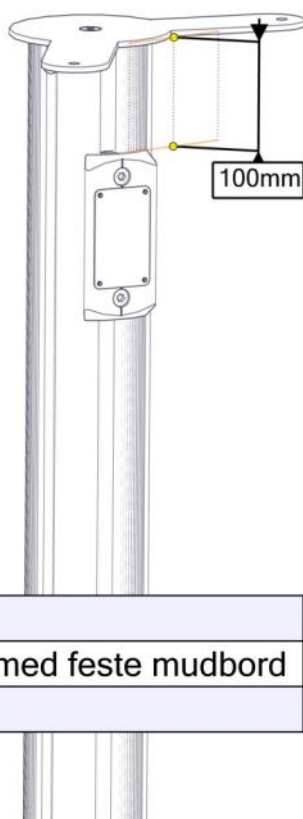

Part Name	Article nr.	Qty
Stolpe L1100=500-600 med feste mudbord	06-200-509	1
Produktmerke	07-500-500	1

Se separat delmontering for detaljer
 See separate assembly for details
 Se separata delmontering för detaljer

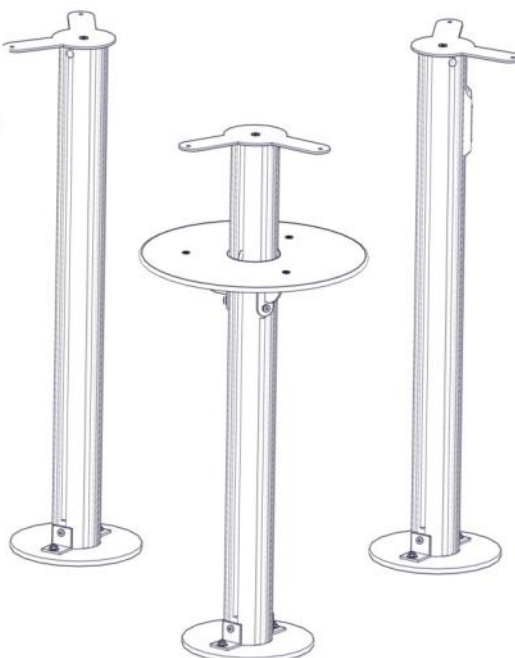

Part Name	Article nr.	Qty
Stolpe L1100=500-600 med feste mudbord	06-200-509	1
Fundamentplate 1x110 stolpe komplett	07-400-101K	3

Se separat delmontering for detaljer
 See separate assembly for details
 Se separata delmontering för detaljer

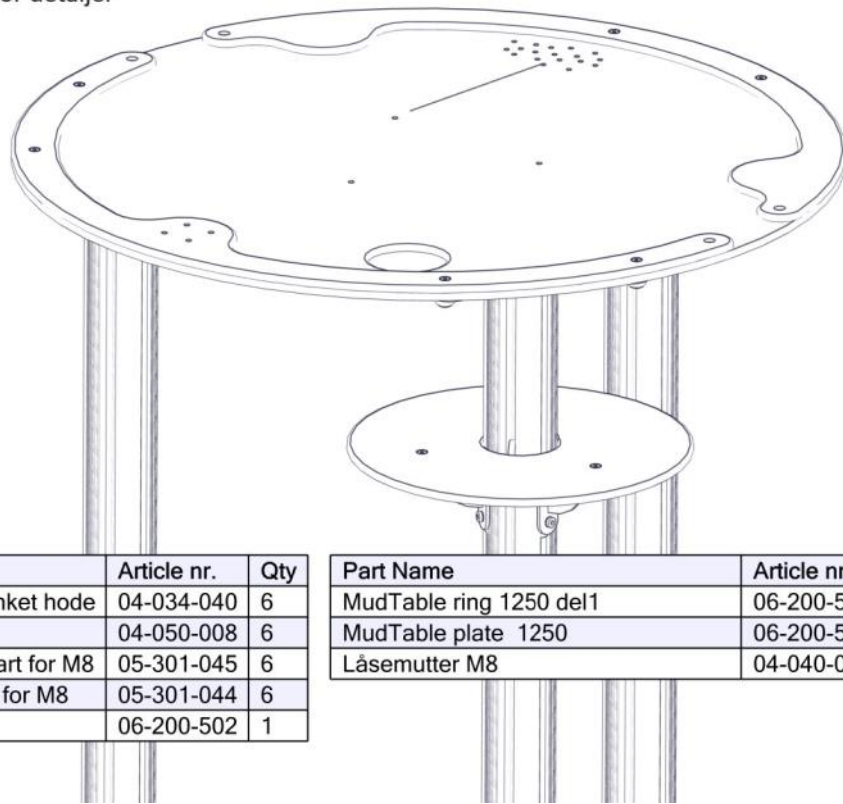

Part Name	Article nr.	Qty
Unbrako skrue M8x40 forsenket hode	04-034-040	6
Skive M8	04-050-008	6
Sikkerhetshette kropp 32 svart for M8	05-301-045	6
Sikkerhetshette 20mm svart for M8	05-301-044	6
MudTable ring 1250 del2	06-200-502	1

Part Name	Article nr.	Qty
MudTable ring 1250 del1	06-200-501	1
MudTable plate 1250	06-200-500	1
Låsemutter M8	04-040-008	6

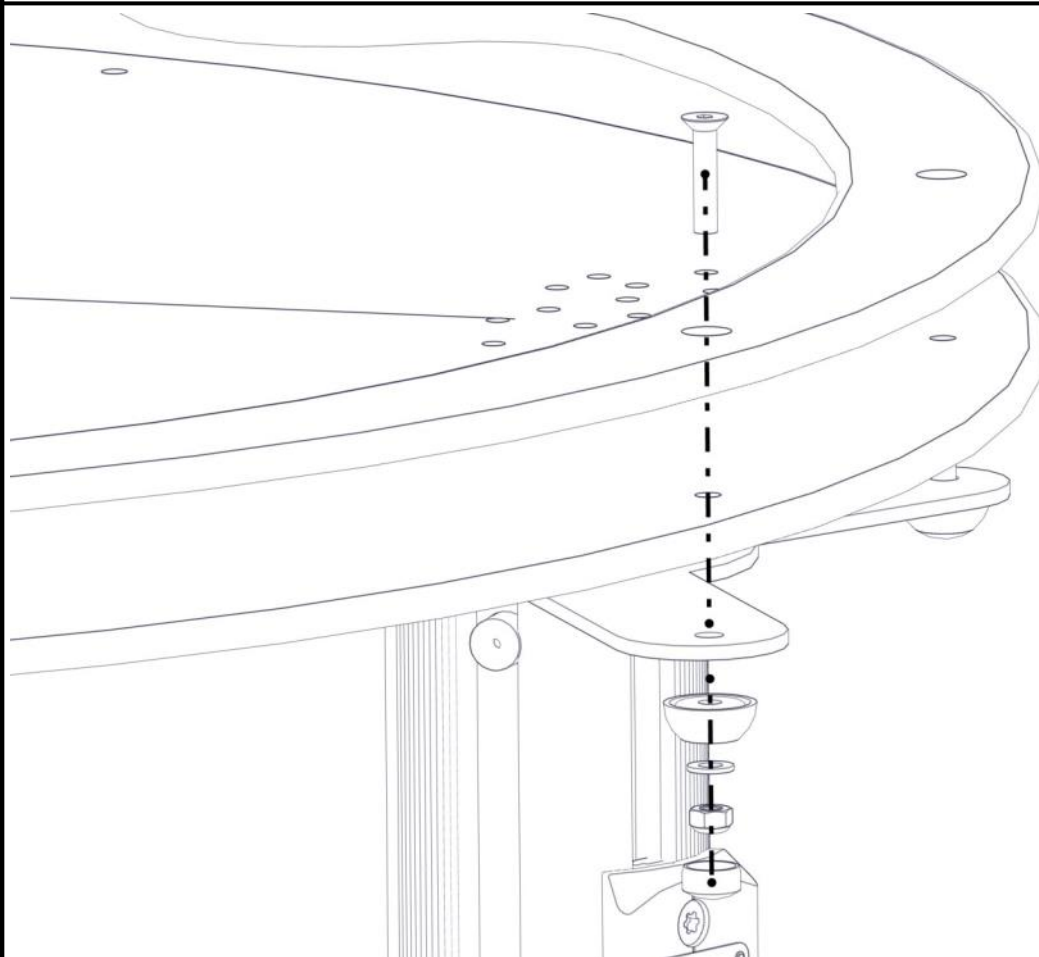

Se separat delmontering for detaljer
 See separate assembly for details
 Se separata delmontering för detaljer

06-200-507K

06-200-506K

Part Name	Article nr.	Qty
Mudbord utløp2	06-200-507K	1
Mudbord utløp1	06-200-506K	1

Se separat delmontering for detaljer
 See separate assembly for details
 Se separata delmontering för detaljer

Part Name	Article nr.	Qty
MudTable kryss med feste på bord	06-200-503K	1

Se separat delmontering for detaljer
See separate assembly for details
Se separata delmontering för detaljer

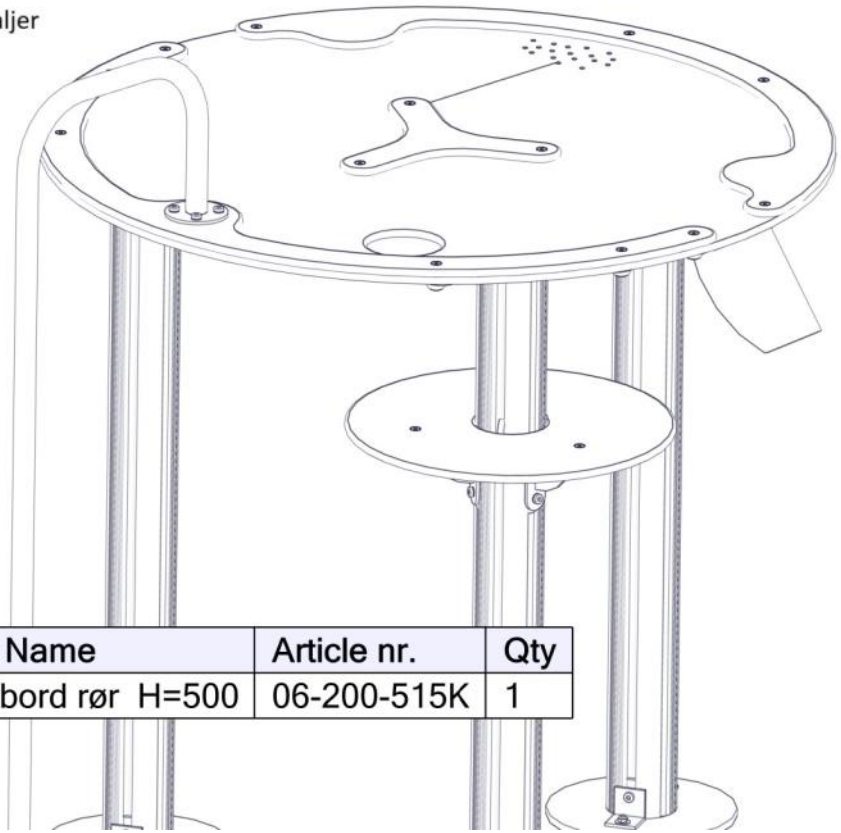



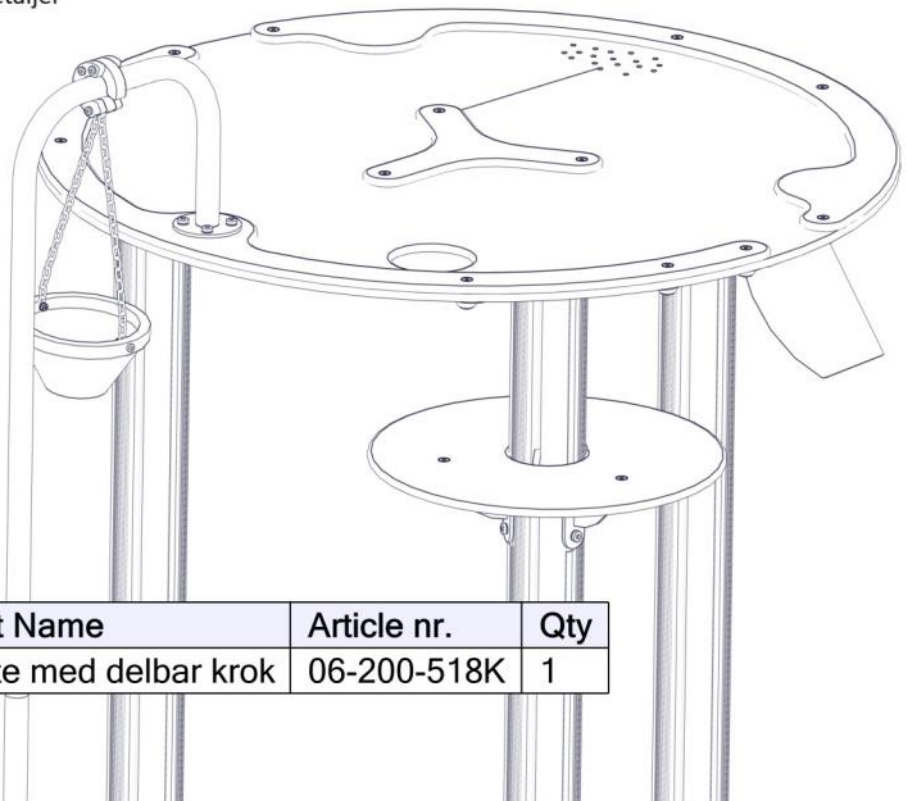

Part Name	Article nr.	Qty
Mudbord rør H=500	06-200-515K	1



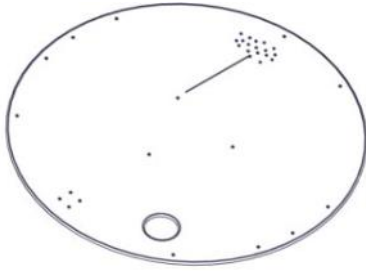

Se separat delmontering for detaljer
See separate assembly for details
Se separata delmontering för detaljer

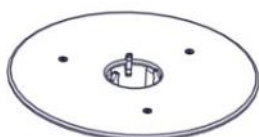

Part Name	Article nr.	Qty
Bøtte med delbar krok	06-200-518K	1

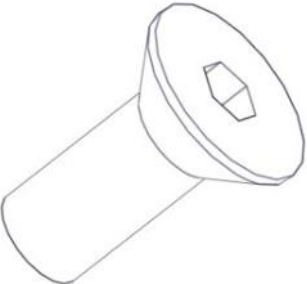

Før utstyret tas i bruk / Before play begins / Innan lekredskapet tas i bruk	
N	<ul style="list-style-type: none"> ● Påse at fallunderlag er utlagt i henhold til gjeldende regler eller vår anbefaling ● Fjern alle monteringshjelpemidler (rester av betong, planker, paller, plast, og lignende) ● Før utstyret tas i bruk, burde man sjekke at det ikke er fare for at anorakksnorer og lignende som kan hekte seg fast noen steder på lekeapparatet. (Vedlagte snor med dobbe (kneledd) kan brukes til å sjekke at dette er i orden. Se vedlagte veiledning for bruk av denne. Dette gjøres for å oppdage eventuelle feilmonteringer.? ● NB! Bør stå i 2-3 dager før bruk
EN	<ul style="list-style-type: none"> ● Make sure the area and depth of safer surfacing are according to the current standard, or to the manufacturer's recommendation ● Make sure all tools and surplus materials are removed before play begins ● PS! When complete, allow 2-3 days for the concrete to set before use
S	<ul style="list-style-type: none"> ● Kontrollera att fallunderlag är utlagt enligt gällande regler eller vårt rekommendation ● Ta bort alla monteringshjälpmedel (rester av betong, plankor, pallar, plast och liknande) ● Innan lekredskapet används, kontrollera att anoracksnoddar eller kläder/delar av kläder eller liknande inte kan fastna i några delar på redskapet. (Den bipackade "knävringen" kan man med fördel användas för denna kontroll. ● Detta görs för att upptäcka eventuella felmonteringar.)

Boltepakker for / Boltpackage for / Bultpaket för		Sign. _____.		
Gul 60-164-910	Navn	Artnr/ dimensjon	Ant	Lev
	Stolpe Ø 110 L=1200 (600-600) Grå Med beslag montert.	06-200-509	3	
	Mudtable bottom Ø 1250x 12 Grå	06-200-500	1	
	MudTable Ring Ø1250 del1 Gul	06-200-501	1	
	MudTable Ring Ø1250 del2 Gul	06-200-502	1	
	MudTable kryss Gul	06-200-503K (se egen del- montering)	1	
	MudTable bucket rest Ø 520 Grønn	06-200-504K (se egen del- montering)	1	

Boltepakker for / Boltpackage for / Bultpaket för		Sign. _____		
Gul 60-164-910	Navn	Artnr/ dimensjon	Ant	Lev
	MudTable utløp type 1 Rød	06-200-506K (se egen del- montering)	1	
	MudTable utløp type 2 Rød	06-200-507K (se egen del- montering)	1	
	MudTable rør H600 Grå	06-200-515K (se egen del- montering)	1	
	Bøtte med delbare krok	06-200-518K (se egen del- montering)	1	
	Produktmerking	06-500-500 (se egen del- montering)	1	
	Unbrako M8x40 forsenket hode	04-034-040	6	

Boltepakker for / Boltpackage for / Bultpaket för

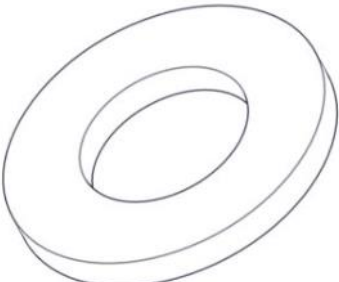
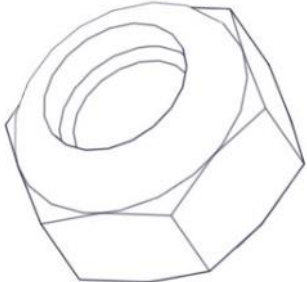
Sign. _____.

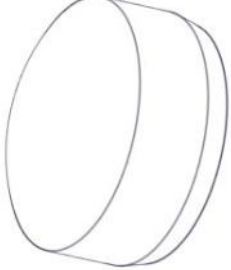
Gul 60-164-910	Navn	Artnr/ dimensjon	Ant	Lev
	Skive M8	04-050-008	6	
	Låsemutter M8	04-040-008	6	
	Sikkerhetslette Kropp 32 Sort	05-301-045	6	
	Sikkerhetslette 20mm hode Sort	05-301-044	6	

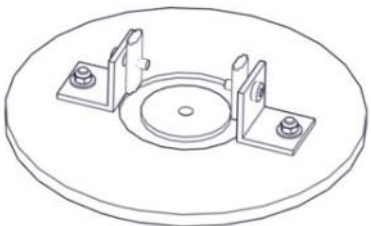
Boltepakker for / Boltpackage for / Bultpaket för		Sign. _____		
Gul 60-164-910	Navn	Artnr/ dimensjon	Ant	Lev
	Fundament Støp			
	Støpefundament Ø110 stolpe	00-003-111K (se egen del- montering)	3	
	Fundament Nedgravning			
	Nedgravningsfundament Ø110 stolpe	07-400-101K (se egen del- montering)	3	

Boltepakker for / Boltpackage for / Bultpaket för

Sign. _____.

Gul 60-164-910	Navn	Artnr/ dimensjon	Ant	Lev
Overflatemon- tering				
	Fundament 1xØ110 for betong- dekke	00-003-113K (se egen del- montering)	3	
	Stolpe Ø 110 må kappes Rør må kappes	06-200-509 06-200-515K	(3) (1)	

Ref
NS-EN 1176-1
§4.2.8.5

(N) (EN) (S)
Bakkenivå Ground level marknivå

Tykkelse/Thickness

betong
concrete
betong

Stolpe kappes: Lengde stolpe - 600 + tykkelse